

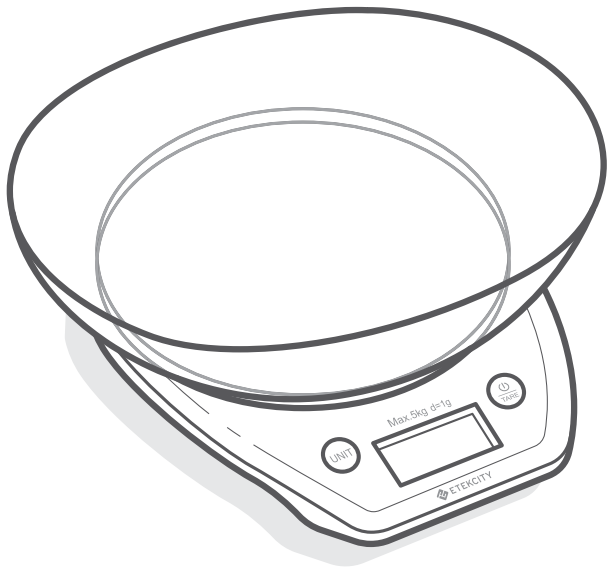

Digital Kitchen Scale

Model: EK5250



**Thank you for purchasing the
Digital Kitchen Scale by Etekcity.**

If you have any questions or concerns, please reach out to our helpful Customer Support Team at support@etekcity.com. We hope you enjoy your new digital kitchen scale!

Table of Contents

Package Contents	3
Specifications	3
Increments	3
Safety Information	4
Function Diagram	5
Digital Display	6
Setup	6
Scale Operation	7
• Measurement	7
• Tare Function	8
Maintenance	8
Troubleshooting	9
Warranty Information	10
Customer Support	11

Package Contents

- 1 x Digital Kitchen Scale
- 1 x Plastic Bowl
- 2 x 1.5V AAA Batteries (Pre-Installed)
- 1 x Quick Start Guide

Specifications

Weight Capacity	176 oz / 11 lb / 5000 g / 5000 mL	
Units	oz / lb:oz / fl'oz (water/milk) / g / mL (water/milk)	
Auto-Off	120 seconds	
Battery	2 x 1.5V AAA batteries	
Dimensions	Scale	8.4 x 6.7 x 1.3 in / 21.4 x 16.9 x 3.3 cm
	Bowl	8.9 x 7.1 x 1.7 in / 22.5 x 18.1 x 4.2 cm

Increments

Measurement Unit	Item Weight	Increment
g	< 1000 g	0.1 g
	1000-5000 g	1 g
oz	< 35 oz	0.01 oz
	35-176 oz	0.05 oz

READ AND SAVE THESE INSTRUCTIONS

Safety Information

To avoid damage to this scale, please read and follow all instructions and safety guidelines in this manual.

Scale

- **Do not** exceed the 11 lb / 5000 g weight capacity, as this will damage the scale. An error indicator will appear on the LCD display if the limit is exceeded.
- **Do not** immerse the scale in water or any liquid. If liquid is spilled on the digital display or buttons, immediately wipe the scale dry with a soft cloth to avoid internal damage.
- Handle with care. This scale is not intended for commercial or heavy-duty use.
- Keep the scale in a cool, dry place. Avoid

exposure to damp environments or extreme temperatures.

- Household use **only**.

Batteries

- **Do not** mix new and old batteries.
- If the low battery indicator (“”) appears on the display, replace the batteries.
- If the scale is not in use for an extended period of time, remove the batteries to conserve battery life and extend the lifetime of the scale.

Function Diagram

- A. Bowl
- B. Digital Scale
- C. Weighing Surface
- D. Unit Switching Button
- E. Digital Display
- F. Power/TARE Button
- G. Battery Compartment
- H. Anti-Skid Padding

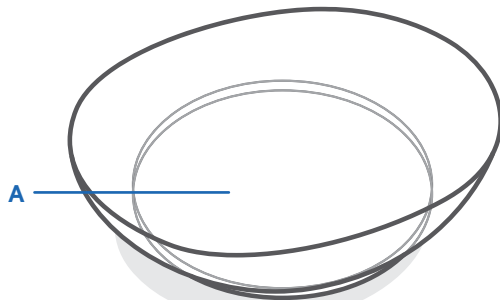

Note: Do not put the plastic bowl in a dishwasher.

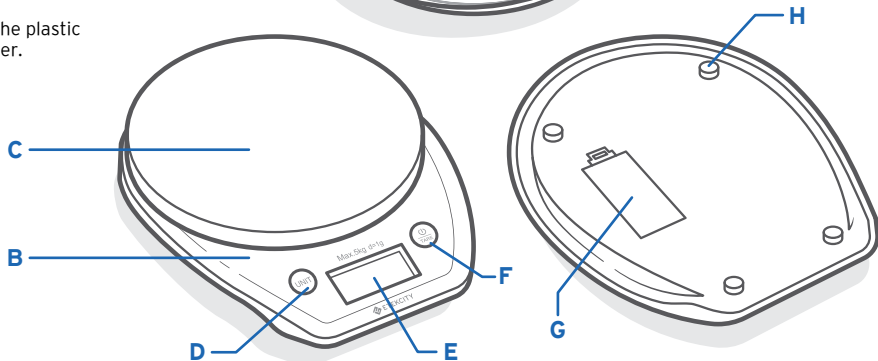

Digital Display

- A. Tare Function
- B. Weight Measurement
- C. Negative Weight Value
- D. Weighing Mode
- E. Measurement Unit

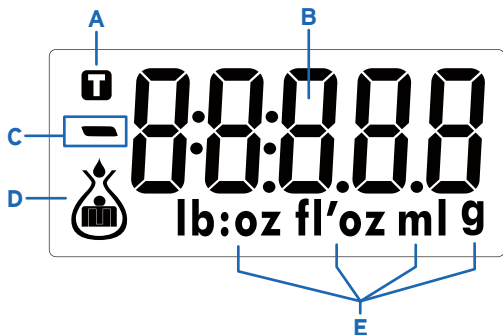

Setup

1. Remove rubber pieces around the scale before using.
2. Open the battery compartment on the underside of the scale.
3. Remove the insulation strip to activate the batteries. *[Figure 1.1]*
4. Replace the battery cover.
5. Press  to turn on the scale.

AAA batteries

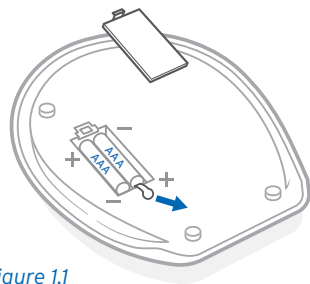

Figure 1.1

Scale Operation

Tips

- For accurate results, always place the scale on a hard, dry, flat surface, and keep the scale away from dirt, dust, vibration, wind, air currents, and electromagnetic interference.
- When you turn on the scale, choose units, or use the tare function, always wait for the scale to read "0.000" before attempting measurement.



Water





Milk



Solid

Figure 2.1

Measurement

1. Press  to turn on the scale. Press **UNIT** to select your desired measuring unit, which will show at the top of the display.
 - a. **Weight:** Choose between grams ("g") or both pounds and ounces ("lb:oz").
 - b. **Volume:** Scale measures in milliliters ("mL") and fluid ounces ("fl'oz"). Select the water () or milk () option. [Figure 2.1]

Note: If you're using the bowl or another container to hold the items or liquid you're measuring, first place the empty container on the scale. Press to tare the container's weight (see **Tare Function**, page 8)

2. Gently place your item on the scale. The display will show the weight or volume.
3. Press and hold  for 3 seconds to turn off the scale.

Note:

- To reset the scale, remove all weight from the platform and press .
- To conserve battery power, the scale will automatically turn off after 2 minutes of inactivity.

Tare Function

Whenever you measure items or liquids inside the included bowl, you can use the tare function to remove the bowl's weight from the final measurement. You can also use other containers in place of the bowl.

1. Place the bowl on the scale. The display will show the bowl's weight. [Figure 3.1]
2. Press . The display will show "0.00" again. [Figure 3.2]

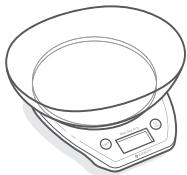

Figure 3.1

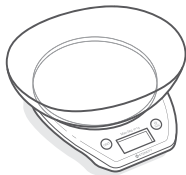

Figure 3.2

3. Place liquid or items in the bowl. The scale will measure the liquid or items without including the weight of the bowl. [Figure 3.3]
4. When you're done, reset the scale by removing all weight and pressing  again.



Figure 3.3

Maintenance

- Use a slightly damp cloth to clean the surface of the scale, followed by a dry, soft cloth to wipe away any moisture.
- You can use a dry, soft cloth to wipe dust off the scale.
- **Do not** wash the plastic bowl in the dishwasher. Hand wash **only**.

Troubleshooting

Problem	Possible Solution
LCD display shows “Lo”.	Battery power is low. Install 2 new 1.5V AAA batteries.
Scale does not turn on.	Batteries may not be properly installed. Insert batteries under the correct polarity as marked in battery compartment.
	Battery power is low. Install 2 new 1.5V AAA batteries.
Display shows “Err”.	Maximum weight capacity has been exceeded. Remove items from scale to avoid damage.
Reading is inaccurate.	Scale may not be level. Place scale on a level surface.
	Reset the scale’s tare measurement, making sure it reads “0” before measuring (see Tare Function , page 8).

If your problem is not listed, please contact **Customer Support** (page 12).

Warranty Information

Product Name	Digital Kitchen Scale
Model	EK5250
For your own reference, we strongly recommend that you record your order ID and date of purchase.	
Order ID	
Date of Purchase	

Terms & Policy

Etekcitey Corporation (“Etekcitey”) warrants this product to the original purchaser to be free from defects in material and workmanship, under normal use and conditions, for a period of **2 years** from the date of original purchase.

Etekcitey agrees, at our option during the warranty period, to repair any defect in material or workmanship or furnish an equal product in exchange without charge, subject to verification of the defect or malfunction and proof of the date of purchase.

There is no other express warranty. This warranty does not apply:

- If the product has been modified from its original condition;
- If the product has not been used in accordance with directions and instructions in the user manual;
- To damages or defects caused by accident, abuse, misuse or improper or inadequate maintenance;
- To damages or defects caused by service or repair of the product performed by an unauthorized service provider or by anyone other than Etekcitey;
- To damages or defects occurring during commercial use, rental use, or any use for which the product is not intended;
- To damages or defects exceeding the cost of the product.

Etekcitey will not be liable for indirect, incidental, or consequential damages in connection with the use of the product covered by this warranty.

This warranty extends only to the original consumer purchaser of the product and is not transferable to any subsequent owner of the product regardless of whether the product is transferred during the specified term of the warranty.

This warranty does not extend to products purchased from unauthorized sellers. Etekcity's warranty extends only to products purchased from authorized sellers that are subject to Etekcity's quality controls and have agreed to follow its quality controls.

All implied warranties are limited to the period of this limited warranty.

This warranty gives you specific legal rights and you may also have other rights which vary from state to state. Some states do not allow the exclusion or limitation of incidental or consequential damages, so the above limitation or exclusion may not apply to you.

If you discover that your product is defective within the specified warranty period, please contact Customer Support via **support@etekcity.com**. **DO NOT** dispose of your product before contacting us. Once our Customer Support Team has approved your request, please return the product with a copy of the invoice and order ID.

Every Etekcity product automatically includes a 2-year warranty. To make the customer support process quick and easy, register your product online at www.etekcity.com/warranty.

This warranty is made by:

Etekcity Corporation
1202 N. Miller St., Suite A
Anaheim, CA 92806

Customer Support

If you have any questions or concerns about your new product, please contact our helpful Customer Support Team.

Etekcite Corporation

1202 N. Miller St., Suite A
Anaheim, CA 92806

Email: support@etekcity.com

Toll-Free: (855) 686-3835

Support Hours

Monday - Friday

9:00 am - 5:00 pm PST/PDT

**Please have your invoice and order ID ready before contacting Customer Support.*



Connect with us @Etekcity

