



Smart Fitness Scale

Model: ESF24 Series

User Manual



Questions or Concerns?

Mon – Fri, 9:00 am – 5:00 pm PST/PDT
support@etekcity.com • (855) 686-3835

Table of Contents

Package Contents	3
Specifications	3
Safety Information	4
Function Diagram	6
Display Diagram	7
Before First Use	8
VeSync App Setup	9
Using the Smart Scale	12
Maintenance	15
Common Display Codes	17
Troubleshooting	18
FCC Statement	21
Warranty Information	22
Customer Support	27

Specifications

Weight Capacity	400 lb / 180 kg / 28 st
Increments	0.2 lb / 0.05 kg
Weight Units	lb / kg / st
Platform	Tempered glass
Battery	3 x 1.5V AAA batteries
Auto-Off	30 seconds
Dimensions	11.8 x 11.8 x 1 in / 30 x 30 x 2.5 cm
Operating System	iOS® 12.0+ or Android™ 6.0+

Package Contents

- 1 x Smart Fitness Scale
- 3 x 1.5V AAA Batteries (Pre-Installed)
- 1 x Quick Start Guide



READ AND SAVE THESE INSTRUCTIONS

Safety Information

Please read and follow all instructions and safety guidelines in this manual.

Medical

- This scale should not be used to diagnose or treat any medical condition.
- Scale data should not be used as a substitute for medical advice from a healthcare professional.
- This scale uses a harmless electrical current to measure body fat. Consult a healthcare professional before using the smart scale if you use medical electronic equipment such as a pacemaker.

General Use

- Check the scale before using. **Do not** use the scale if it is damaged in any way.
- **Do not** strike or hit the scale. **Do not** use the scale if the glass is cracked or broken. Due to the nature of tempered glass, the glass will shatter if there is even a slight crack. If you see a crack, contact **Customer Support** immediately (page 27).



- The glass platform is slippery when wet. **Always** make sure the platform and your feet are dry before stepping on for measurement.
- Place the scale on a hard, flat surface to avoid tipping.
- To weigh safely and accurately, stand with your feet shoulder-width apart while on the scale. **Do not** stand on the edge of the scale or jump on the scale.
- Avoid standing on the scale for a long period of time, or when you are not weighing yourself.
- **Do not** overload the scale. Maximum weight capacity is 400 lb / 180 kg / 28 st.
- Keep the scale in a cool area with low humidity. Keep the scale away from heat sources, such as ovens or heaters. Avoid temperature fluctuations. Store the scale in a horizontal position, not vertical.
- Handle with care. Not for commercial use. Household use **only**.

Batteries

- **Do not** mix new and old batteries.
- If the scale is not in use for a long period of time, remove the batteries to extend the lifetime of the scale.



Function Diagram

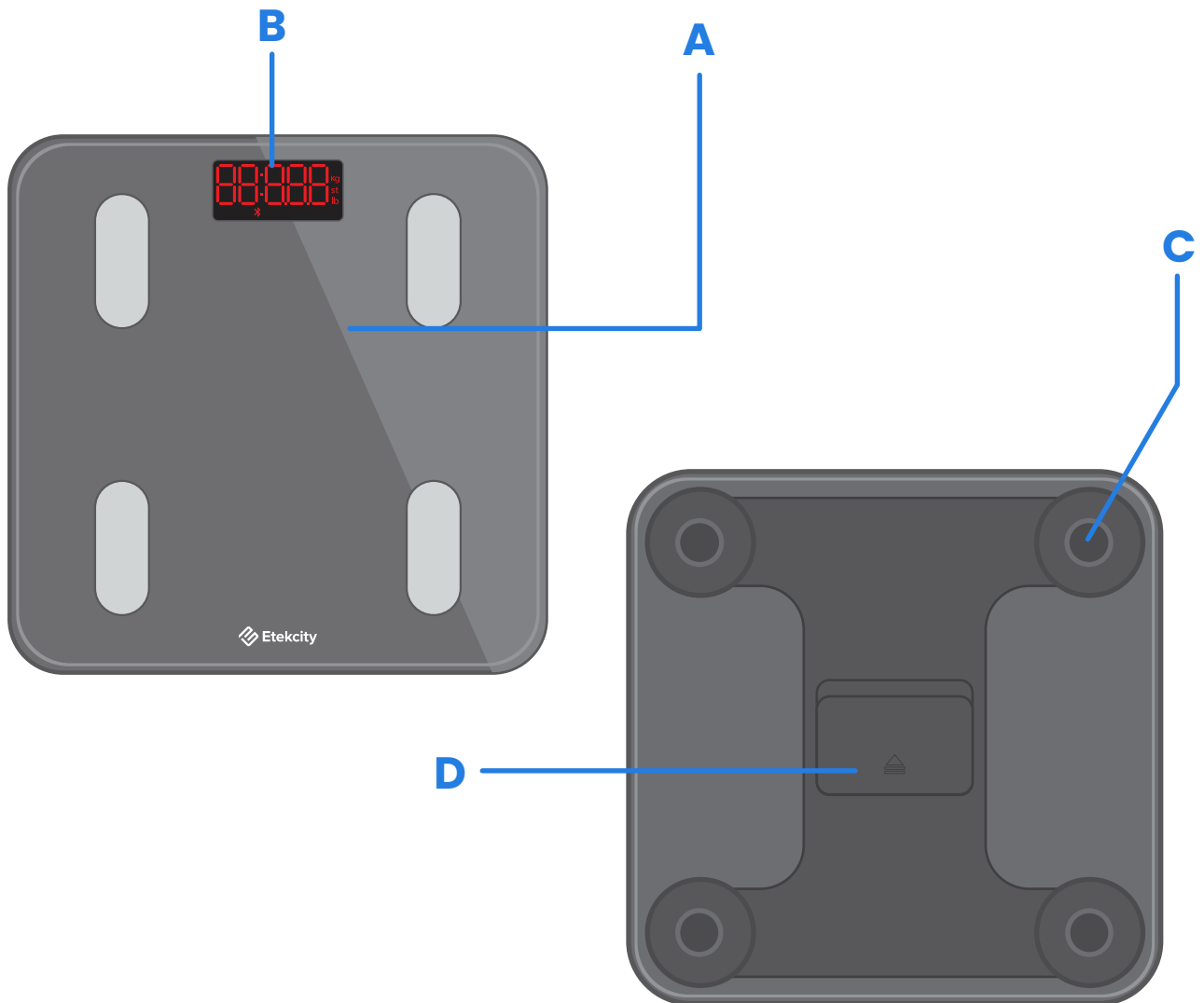

- A.** Weighing Platform
- B.** Display
- C.** Anti-Skid Padding
- D.** Battery Compartment



Display Diagram

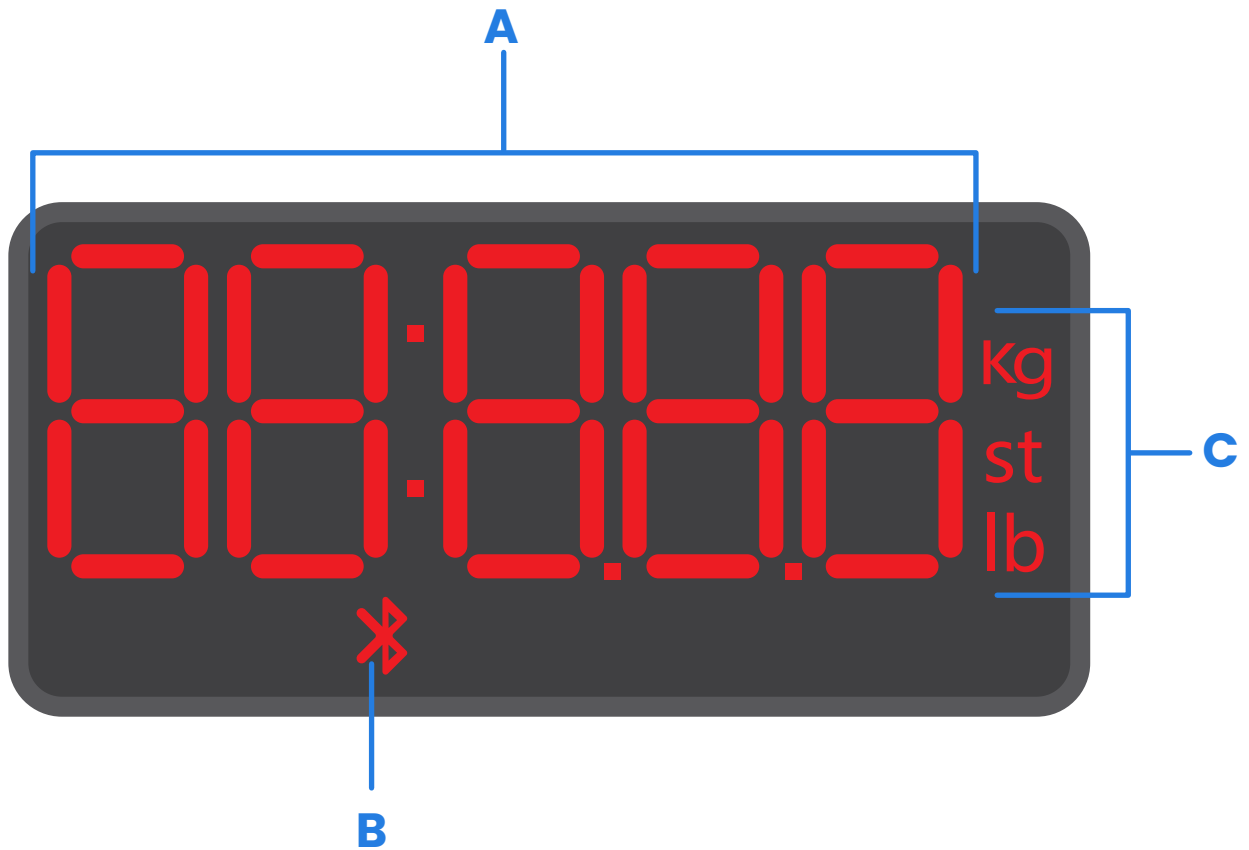

- A.** Weight Measurement
- B.** Bluetooth® Icon
- C.** Weight Units



Before First Use

1. Open the battery compartment on the underside of the scale. Remove the included AAA batteries.
2. Remove the plastic insulator strip from the battery compartment.
3. Replace the batteries. Follow the guidelines in the battery compartment to match the **+** and **-** terminals.

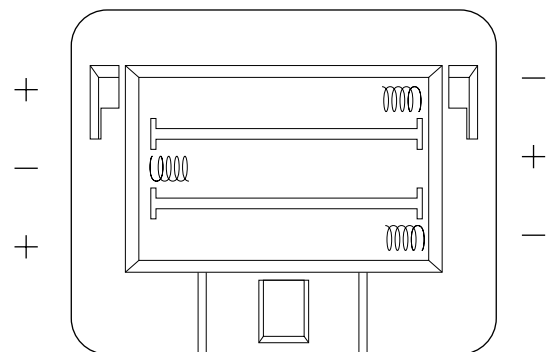
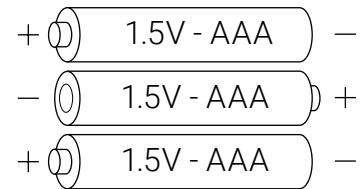
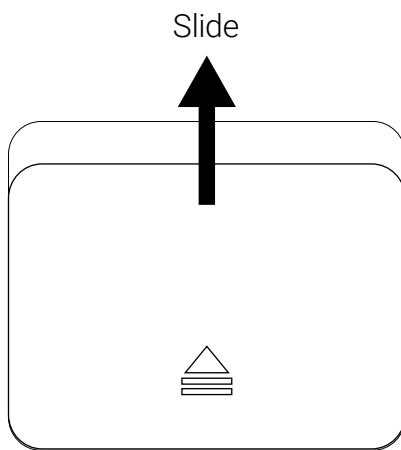

VeSync App Setup

Note: Due to app updates and improvements, the VeSync app may be slightly different than shown in the manual. In case of any differences, follow the in-app instructions.

1. To download the VeSync app, scan the QR code or search “VeSync” in the Apple App Store® or Google Play Store.

Note:

- This scale uses the VeSync app, not the VeSyncFit app.
- For Android users, you may need to select “Allow” to use VeSync.



2. Open the VeSync app. If you already have an account, tap **Log In**. To create a new account, tap **Sign Up**.

Note: You must create your own VeSync account to use third-party services and products. These will not work with a guest account. With a VeSync account, you can also allow your family and friends to use your smart fitness scale.

3. Make sure to enable Bluetooth® permission of the APP and turn on Bluetooth®. For Android users, please allow the app to access nearby devices in your phone settings.

Note: If your Android phone system is lower than Android™ 12.0+, please authorize the location (GPS) permission of the VESYNC app in your phone settings.

4. Tap **+** in the VeSync app and select your smart fitness scale.
5. Follow the in-app instructions to connect to your smart fitness scale.

Note: You can change the name and icon at any time in the smart fitness scale settings.



Creating a User

If you are a new user, you will need to enter physical information before weighing yourself for the first time so the scale can calculate your body metrics. Follow the in-app instructions to create a user.

Note:

- *Entering inaccurate information will make the scale's measurements less accurate.*
- *If you don't identify with the available gender options, or are unsure, pick the option that you think best physically matches you. This choice is used for physical measurements, such as body fat percentages.*



Using the Smart Scale

Note:

- To see measurements besides weight, you must connect the scale to the VeSync app (see page 9).
- If you are pregnant, scale measurements will not be accurate.

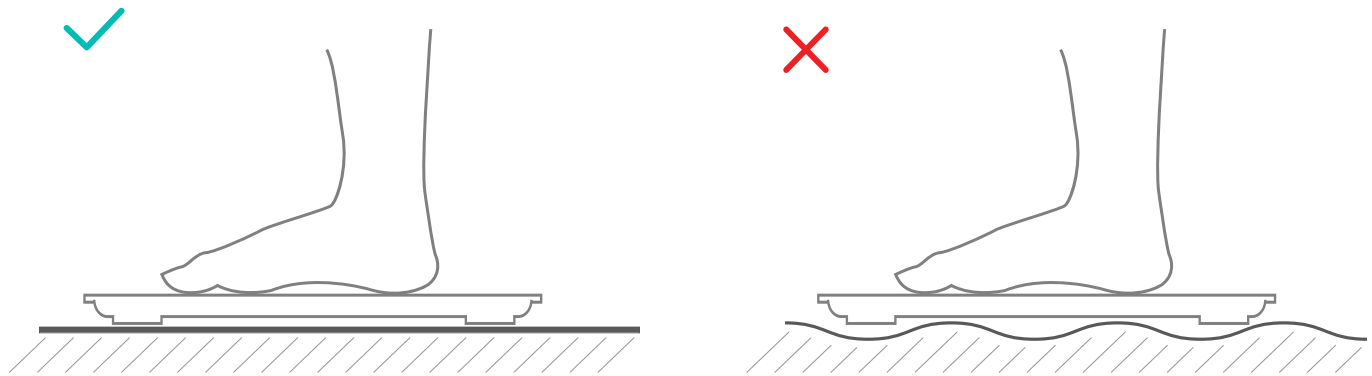

1. Place the scale on a hard, flat surface (not a carpet or mat). **[Figure 1.1]**

Note: Placing on carpet may cause inaccurate measurements or tipping.



[Figure 1.1]



2. Step on the scale, then step off. Wait for the LED screen to display “0.0” before using.
3. Place dry, bare feet on the scale’s conductive areas. Stand on the scale until the display flashes several times, showing your final measurement. **[Figure 1.2]** If your smart scale is connected to the VeSync app, additional results (such as BMI, body fat, etc.) will show in the app.
4. If you want to measure the weight of your baby or pet using the VeSync app, tap  (Expand) on the home page and then tap  (Baby Mode). Follow the in-app instructions. In Baby Mode, the APP will only measure weight and BMI.

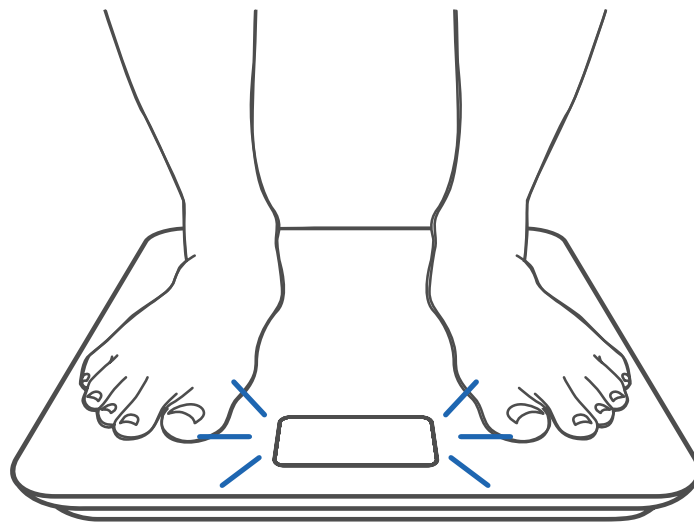

[Figure 1.2]



Switching Units

1. To change the unit of measurement (kg, lb, or st), lightly tap on the scale and open the VeSync app. Select the scale (you should see “Connected” in the app), then tap the Settings icon (⚙️). You can adjust the units on this page. **[Figure 1.3]**
2. The default unit is pounds (lb). After changing units, the scale will show the new unit of measurement.

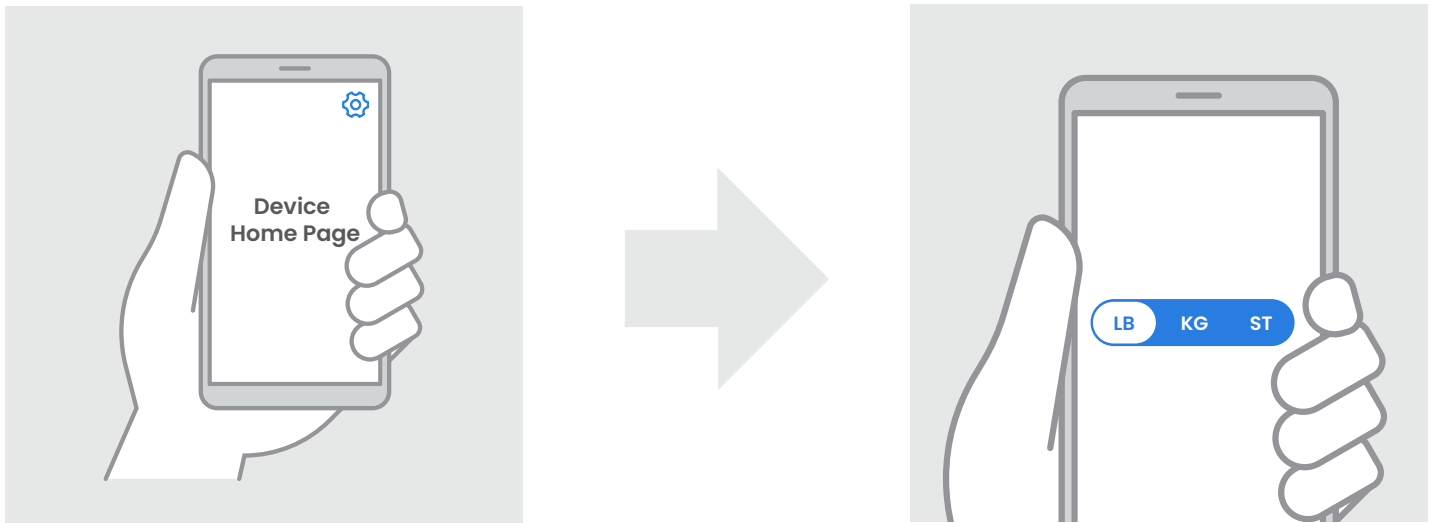

[Figure 1.3]



Maintenance

Clearing the Smart Scale

If the scale has been moved or flipped upside down, it must be cleared to ensure accurate results.

1. Place the scale on a hard, flat surface.
2. Step on the scale until digits appear on the display, then step off. [\[Figure 2.1\]](#)
3. The scale will show “000” when cleared. [\[Figure 2.2\]](#)

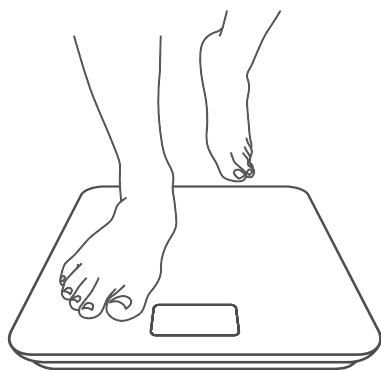

[\[Figure 2.1\]](#)



[\[Figure 2.2\]](#)



Cleaning the Smart Scale

- Use a slightly damp cloth to clean the surface of the scale, followed by a soft, dry cloth to wipe away any remaining moisture.
- **Do not** use chemical or abrasive cleaning agents to clean the scale.

Replacing the Batteries

The display will show “” when the batteries need to be replaced.

1. Open the battery compartment on the underside of the scale.
2. Remove the old batteries and dispose of them properly.
3. Install 3 new 1.5V AAA batteries, making sure they are placed under the correct polarity.
4. Replace the battery compartment cover.

Note: *The scale may need to be cleared after replacing the batteries.*



Common Display Codes



Wireless Connection



No Wireless Connection



Clearing



Overload



Change Battery



Troubleshooting

The scale doesn't turn on.

- Check if the batteries are properly installed. If using the scale for the first time, remove the plastic insulator strip from the battery compartment.

Information flashes on the display and then disappears.

- The batteries are low and may need to be replaced.

The smart scale doesn't connect with the VeSync app.

- Make sure your phone's operating system is running on iOS 12.0+ or Android 6.0+.
- Close and relaunch the VeSync app. Make sure you're using the latest version.
- Make sure to enable Bluetooth® permission of the APP and turn on Bluetooth®. For Android users, please allow the app to access nearby devices in your phone settings.

Note: *If your Android phone system is lower than Android™ 12.0+, please authorize the location (GPS) permission of the VeSync app in your phone settings.*

- Make sure your scale and phone are within 30 ft / 10 m of each other.
- Make sure the scale is not currently connected to any other phone or app.
- Try turning off any VPN apps.



My scale will only measure my weight, not my body fat or other metrics.

- Set up your smart scale in the VeSync app. Your weight will show on the scale display, and more results will show on the app.
- If you're wearing shoes or socks, the scale cannot measure health metrics such as body fat. Step on the scale with bare feet. [\[Figure 3.1\]](#)
- Make sure to place your feet on the scale's conductive areas. [\[Figure 3.2\]](#)
- If your feet are too dry or too wet, the biometrics may not be detected. Since skin can become very dry during winter, please also try to apply some lotion or have a foot soak when it cannot measure other measurement values.

Note: If the scale has errors on the display, will not turn off automatically, or has a problem not listed here, try removing the batteries for 3 seconds, then replacing them.

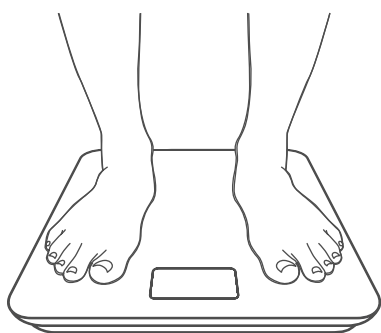

[\[Figure 3.1\]](#)

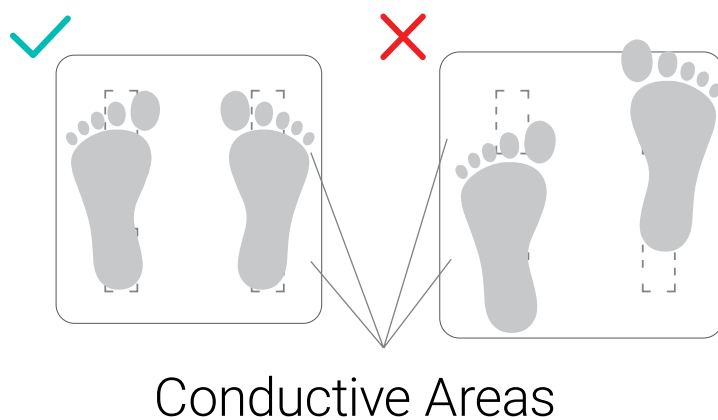

[\[Figure 3.2\]](#)

If you still need help, please contact [Customer Support](#) (page 27).



Attributions

iOS is a registered trademark of Cisco Systems, Inc. and/or its affiliates in the United States and certain other countries.

Apple App Store is a trademark of Apple Inc.

Android and Google Play are trademarks of Google LLC.

The Bluetooth® word mark and logos are registered trademarks owned by Bluetooth SIG, Inc. and any use of such marks by Etekcity Corporation is under license. Other trademarks and trade names are those of their respective owners.



Federal Communication Commission

Interference Statement

This device complies with Part 15 of the FCC Rules. Operation is subject to the following two conditions:

- (1) This device may not cause harmful interference, and
- (2) This device must accept any interference received, including interference that may cause undesired operation.

NOTE: This equipment has been tested and found to comply with the limits for a Class B digital device, pursuant to Part 15 of the FCC Rules. These limits are designed to provide reasonable protection against harmful interference in a residential installation. This equipment generates, uses and can radiate radio frequency energy and, if not installed and used in accordance with the instructions, may cause harmful interference to radio communications. However, there is no guarantee that interference will not occur in a particular installation. If this equipment does cause harmful interference to radio or television reception, which can be determined by turning the equipment off and on, the user is encouraged to try to correct the interference by one or more of the following measures:

- Reorient or relocate the receiving antenna.
- Increase the separation between the equipment and receiver.
- Connect the equipment into an outlet on a circuit different from that to which the receiver is connected.
- Consult the dealer or an experienced radio/TV technician for help.

FCC Caution: Any changes or modifications not expressly approved by the party responsible for compliance could void the user's authority to operate this equipment.

FCC Radiation Exposure Statement

This equipment complies with FCC radiation exposure limits set forth for an uncontrolled environment. End users must follow the specific operating instructions for satisfying RF exposure compliance. To maintain compliance with FCC RF exposure compliance requirements, please follow operation instructions as documented in this manual. This transmitter must not be co-located or operating in conjunction with any other antenna or transmitter. The availability of some specific channels and/or operational frequency bands are country dependent and are firmware programmed at the factory to match the intended destination. The firmware setting is not accessible by the end user.



Warranty Information

Product	Smart Fitness Scale
Model	ESF24 Series
For your own reference, we strongly recommend that you record your order ID and date of purchase.	

Etekcitey Limited Product Warranty

Register your products at <https://warranty.etekcity.com/warranty> to stay up to date with important product information such as product updates, limited warranties, usage and maintenance recommendations, and notifications concerning safety warnings or product recalls. Registration is not required to claim your limited warranty.

Two (2) Year Limited Consumer Product Warranty

Etekcitey Corporation (“Etekcitey”) warrants that the product shall be free from defects in material and workmanship for a period of **2 years from the date of original purchase** (“Limited Warranty Period”), provided the product was used in accordance with its use and care instructions (e.g. in the intended environment and under normal circumstances).

Your Limited Warranty Benefits

During the Limited Warranty Period and subject to this limited Warranty Policy, Etekcitey will, in its sole and exclusive discretion, either (i) refund the purchase price if the purchase was made directly from the online Etekcitey store, (ii) repair any defects in material or workmanship, (iii) replace the product with another product of equal or greater value, or (iv) provide store credit in the amount of the purchase price.

Who is Covered?

This limited warranty extends only to the original consumer purchaser of the product and is not transferable to any subsequent owner of the product, regardless of whether the product transferred ownership during the specified term of the limited warranty. The original consumer purchaser must provide verification of the defect or malfunction and proof of the date of purchase to claim the Limited Warranty Benefits.

Be Aware of Unauthorized Dealers or Sellers.

This limited warranty does not extend to products purchased from unauthorized dealers or sellers. Etekcitey's limited warranty only extends to products purchased from authorized dealers or sellers that are subject to Etekcitey's quality controls and have agreed to follow its quality controls. Please be aware, products purchased from an unauthorized website or dealer may be counterfeit, used, defective, or may not be designed for use in your country. You can protect yourself and your products by making sure you only purchase from Etekcitey or its authorized dealers.

If you have any questions about a specific seller, or if you think you may have purchased your product from an unauthorized seller, please contact our Customer Support via support@etekcity.com.

What's Not Covered?

- Normal wear and tear, including parts that might wear out over time (e.g. batteries, filters, cleaning brush, essential oil pads, etc.).
- If the proof-of-purchase has been altered in any way or is made illegible.
- If the model number, serial number or production date code on the product has been altered, removed or made illegible.
- If the product has been modified from its original condition.
- If the product has not been used in accordance with directions and instructions in the user manual.
- Damages caused by connecting peripherals, additional equipment or accessories other than those recommended in the user manual.
- Damages or defects caused by accident, abuse, misuse, or improper or inadequate maintenance.
- Damages or defects caused by service or repair of the product performed by an unauthorized service provider or by anyone other than Etekcitey.



- Damages or defects occurring during commercial use, rental use, or any use for which the product is not intended.
- If the unit has been damaged, including but not limited to damage by animals, lightning, abnormal voltage, fire, natural disaster, transportation, dishwasher, or water (unless the user manual expressly states that the product is dishwasher safe).
- Incidental and consequential damages.
- Damages or defects exceeding the cost of the product.

Claiming Your Limited Warranty Service in 5 Simple Steps:

1. Make sure your product is within the specified limited warranty period.
2. Make sure you have a copy of the invoice and order ID or proof-of-purchase.
3. Make sure you have your product. **DO NOT** dispose of your product before contacting us.
4. Contact our Customer Support team via support@etekcity.com.
5. Once our Customer Support team has approved your request, please return the product with a copy of the invoice and order ID.

Sole and Exclusive Remedy.

THE FOREGOING LIMITED WARRANTY CONSTITUTES ETEKCITY CORPORATION'S EXCLUSIVE LIABILITY, AND YOUR SOLE AND EXCLUSIVE REMEDY, FOR ANY BREACH OF ANY WARRANTY OR OTHER NONCONFORMITY OF THE PRODUCT COVERED BY THIS LIMITED PRODUCT WARRANTY STATEMENT. THIS LIMITED WARRANTY IS EXCLUSIVE, AND IN LIEU OF ALL OTHER WARRANTIES. NO EMPLOYEE OF ETEKCITY CORPORATION OR ANY OTHER PARTY IS AUTHORIZED TO MAKE ANY WARRANTY IN ADDITION TO THE LIMITED WARRANTY IN THIS LIMITED PRODUCT WARRANTY STATEMENT.

Disclaimer of Limited Warranties.

TO THE FULLEST EXTENT PROVIDED BY APPLICABLE LAW, EXCEPT AS WARRANTED IN THIS LIMITED PRODUCT WARRANTY POLICY, ETEKCITY CORPORATION PROVIDES THE PRODUCTS YOU PURCHASE FROM ETEKCITY CORPORATION "AS IS" AND ETEKCITY CORPORATION HEREBY DISCLAIMS ALL WARRANTIES OF ANY KIND, WHETHER EXPRESS OR IMPLIED, STATUTORY, OR OTHERWISE, INCLUDING BUT NOT LIMITED TO ANY



WARRANTIES OF MERCHANTABILITY, NON-INFRINGEMENT, AND FITNESS FOR PARTICULAR PURPOSE.

Limitations of Liability

TO THE FULLEST EXTENT PROVIDED BY APPLICABLE LAW, IN NO EVENT WILL ETEKCITY CORPORATION, ITS AFFILIATES, OR THEIR LICENSORS, SERVICE PROVIDERS, EMPLOYEES, AGENTS, OFFICERS, OR DIRECTORS BE LIABLE FOR:

(a) DAMAGES OF ANY KIND ARISING OUT OF OR IN CONNECTION WITH PRODUCTS PURCHASED FROM ETEKCITY CORPORATION IN EXCESS OF THE PURCHASE PRICE PAID BY THE PURCHASER FOR SUCH PRODUCTS, OR

(b) INDIRECT, SPECIAL, INCIDENTAL, CONSEQUENTIAL, OR PUNITIVE DAMAGES EVEN IF ETEKCITY CORPORATION OR ONE OF ITS SUPPLIERS HAS BEEN ADVISED OF THE POSSIBILITY OR LIKELIHOOD OF SUCH DAMAGES.

AND REGARDLESS OF WHETHER CAUSED BY TORT (INCLUDING NEGLIGENCE), BREACH OF CONTRACT, OR OTHERWISE. OUR LIABILITY SHALL UNDER NO CIRCUMSTANCES EXCEED THE ACTUAL AMOUNT PAID BY YOU FOR THE DEFECTIVE PRODUCT, NOR SHALL WE UNDER ANY CIRCUMSTANCES BE LIABLE FOR ANY CONSEQUENTIAL, INCIDENTAL, SPECIAL OR PUNITIVE DAMAGES OR LOSSES, WHETHER DIRECT OR INDIRECT.

EXCEPT AS COVERED BY THIS LIMITED PRODUCT WARRANTY STATEMENT, ETEKCITY CORPORATION SHALL NOT BE LIABLE FOR COSTS ASSOCIATED WITH THE REPLACEMENT OR REPAIR OF PRODUCTS PURCHASED FROM IT, INCLUDING, BUT NOT LIMITED TO, LABOR, INSTALLATION, OR OTHER COSTS INCURRED BY THE USER AND, IN PARTICULAR, ANY COSTS RELATING TO THE REMOVAL OR REPLACEMENT OF ANY PRODUCT.

OTHER RIGHTS YOU MAY HAVE

SOME JURISDICTIONS DO NOT ALLOW FOR: (1) EXCLUSION OF IMPLIED WARRANTIES; (2) LIMITATION ON THE DURATION OF IMPLIED WARRANTIES; AND/OR (3) EXCLUSION OR LIMITATION OF INCIDENTAL OR CONSEQUENTIAL DAMAGES; SO THE DISCLAIMERS IN THIS POLICY MAY NOT APPLY TO YOU. IN THESE JURISDICTIONS YOU HAVE ONLY THE IMPLIED WARRANTIES THAT ARE EXPRESSLY REQUIRED TO BE PROVIDED IN ACCORDANCE WITH APPLICABLE



LAW. THE LIMITATIONS OF WARRANTIES, LIABILITY, AND REMEDIES APPLY TO THE MAXIMUM EXTENT PERMITTED BY LAW.

ALTHOUGH THIS LIMITED WARRANTY GIVES YOU SPECIFIC LEGAL RIGHTS, YOU MAY HAVE OTHER RIGHTS IN YOUR JURISDICTION. THIS STATEMENT OF LIMITED WARRANTY IS SUBJECT TO APPLICABLE LAWS THAT APPLY TO YOU AND THE PRODUCT. PLEASE REVIEW THE LAWS IN YOUR JURISDICTION TO UNDERSTAND YOUR RIGHTS FULLY.

CHANGES TO THIS POLICY

We may change the availability of this limited warranty at our discretion, but any changes will not be retroactive.

This warranty is made by:

Etekcity Corporation
1202 N. Miller St., Suite A
Anaheim, CA 92806
USA



Customer Support

If you have any questions or concerns about your new product, please contact our helpful Customer Support Team.

Etekcitey Corporation

1202 N. Miller St., Suite A
Anaheim, CA 92806
USA

Email: support@etekcity.com

Toll-Free: (855) 686-3835

Support Hours

Mon–Fri, 9:00 am–5:00 pm PST/PDT

**Please have your order invoice and order ID ready before contacting Customer Support.*



